

# OPERATION MANUAL

REMOTE CONTROLLER  
RC02-PAX  
RC02-PBX



Part No. Z1-000-262, IA002551

The specifications of this product and the contents of this Operation Manual are subject to change without prior notice.

Copyright© 1992-2000 Kikusui Electronics Corporation

All rights reserved.

Printed in Japan

## ◆ Receiving Inspection

Upon receipt of the remote controller, please immediately inspect it to check that it has not been damaged when in transportation. Also check that the accessories are not missing.

## ◆ Accessories

The following accessories accompany the remote controller.

- Cable (2 meters long) with miniplug (with cable lock) ..... 1 piece
- Magnet sheet (seal on one side) ..... 1 sheet
- Operation manual ..... 1 copy

### **Caution**

- The magnet sheet has strong magnetism. Do not put it near a memory device or devices vulnerable to magnetism--such as floppy disks or magnetic cards. If you put it near such a memory device or devices, it will destroy data stored on the memory device or devices.

Keep this manual near the remote controller so that you can refer to this manual whenever you want to.

# TABLE OF CONTENTS

	PAGE
<b>Chapter 1. GENERAL</b> .....	1
1.1 Introduction .....	1
1.2 Features .....	1
<b>Chapter 2. PREPARATION</b> .....	2
2.1 Layout of Panel Items .....	2
2.2 Connecting the Cable .....	4
2.3 Attaching the Magnet Sheet .....	5
2.4 Reference Card .....	5
<b>Chapter 3. PRECAUTIONS</b> .....	6
<b>Chapter 4. INSPECTION AND MAINTENANCE</b> .....	7
<b>Chapter 5. SPECIFICATIONS</b> .....	9
5.1 Ambient Conditions .....	9
5.2 Display .....	9
5.3 Power Consumption .....	9
5.4 Dimensions and Weight .....	9
5.5 Accessories .....	9
<b>Appendix: EXTERNAL VIEWS AND DIMENSIONS</b> .....	10

# Chapter 1. GENERAL

## 1.1 Introduction

Models RCO2-PAX and RC02-PBX Remote Controllers are for remote control of Models PAX and PBX DC Power Supplies, respectively. The panels of the remote controllers are identical with the front panels of the respective power supplies, thereby allowing you to virtually extend the front panels themselves of the power supplies.

Before start using these instruments, read this manual and that of the corresponding power supply.

**Caution**

- In the text of this manual, term "remote controller" is used to denote Model RC02-PAX or RC02-PBX Remote Controller and term "power supply" to denote Model PAX or PBX Power Supply.

## 1.2 Features

(1) **LCD display (20 columns, 2 rows)**

The LCD display of the remote controller allows you to view data in the same manner as that of the power supply allows you. The contrast of display is adjustable with the contrast control to suit the conditions of use.

(2) **Good operability**

The remote controller has numeric entry keys, arrow keys, and JOG/SHUTTLE dials, allowing you to enter numerical values and select menu items, conveniently in an analog style.

## Chapter 2. PREPARATION

### 2.1 Layout of Panel Items

The layout of the panel items of each remote controller are shown below. For the operation method of these panel items, refer to Chapter 3 of the operation manual of the power supply.

#### a) RC02-PAX

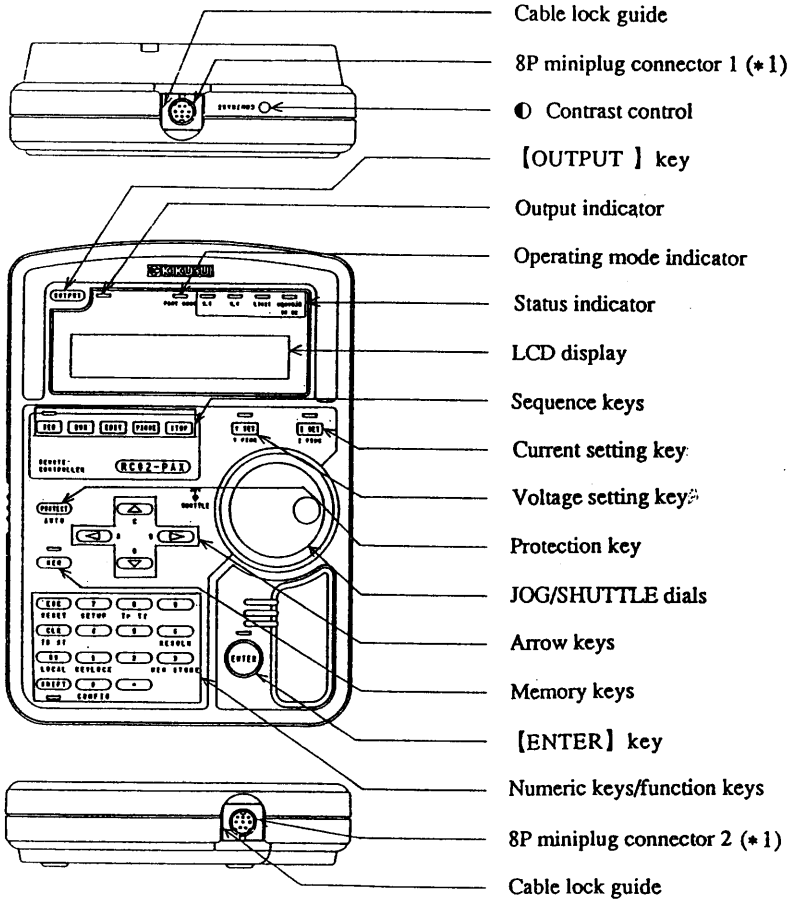

b) RC02-PBX

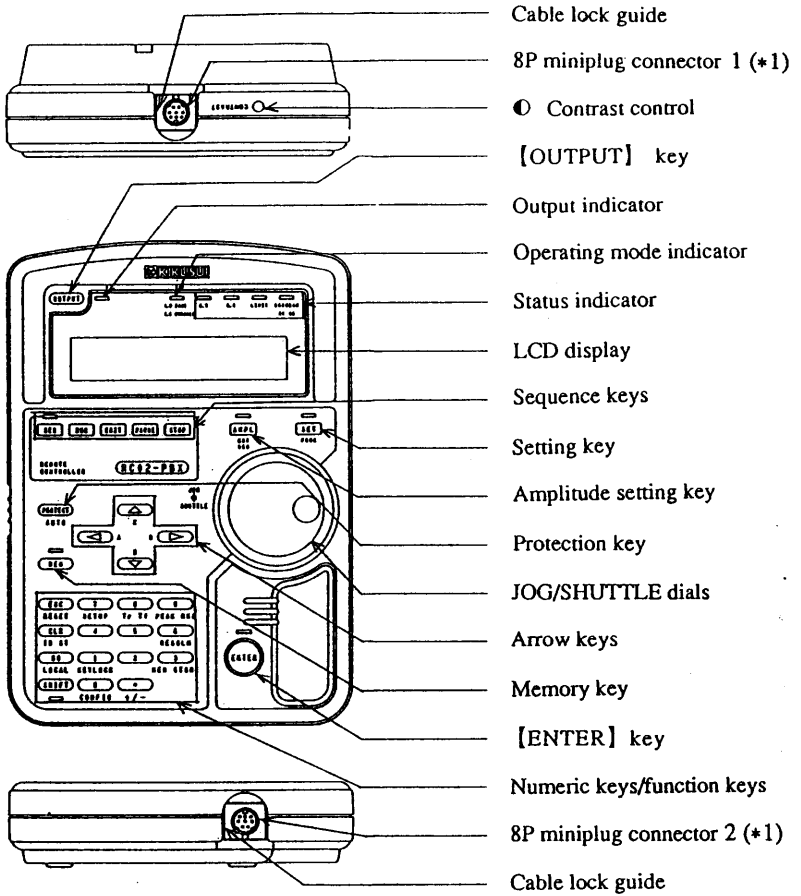

\* 1: Use one of the connectors 1 and 2. Do not use both of them at the same time.

## 2.2 Connecting the Cable

Connect one end (which has the 8P miniplug with cable lock) of the cable to 8P miniplug 1 or 2 of the remote controller. To secure the cable, turn the cable lock clockwise as illustrated below. Connect the other end of the cable to connector J1 on the front sub-panel of the power supply.

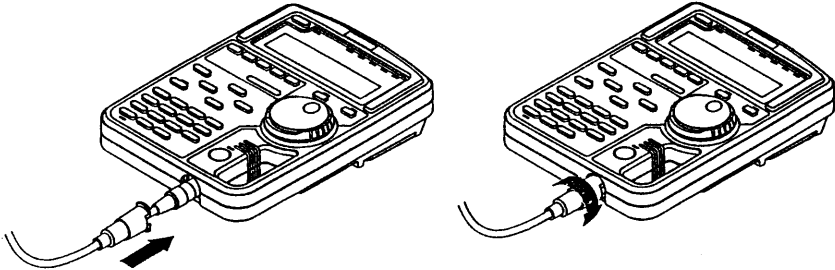
**Caution**

- Never connect or disconnect the cable when power of the power supply is on. Before connecting the cable, be certain that power of the power supply is off.



## 2.3 Attaching the Magnet Sheet

Remove the seal of the magnet sheet that is supplied accompanying the remote controller, and attach the magnet sheet onto the bottom of the remote controller.

### **WARNINGS**

- The magnet sheet has strong magnetism. Never put it near a memory device or devices vulnerable to magnetism--such as floppy disks or magnetic cards. If you put it near such a memory device or devices, it will destroy data stored on the memory device or devices. You may neglect this instruction only on your own risk.
- The magnet sheet is to be used to prevent slipping of the remote controller on a horizontal plane only. It is not for attaching the remote controller onto a vertical plane--never attempt to use it in this manner as the remote controller may fall down and may destroy itself or hurt you.

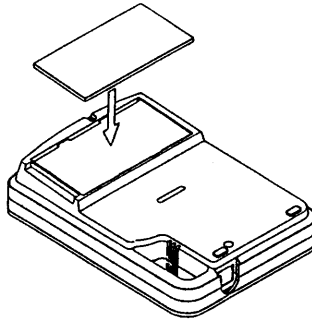

## 2.4 Reference Card

The reference card can be pulled out to the right as illustrated below. It shows the sequence data and program edit display data.

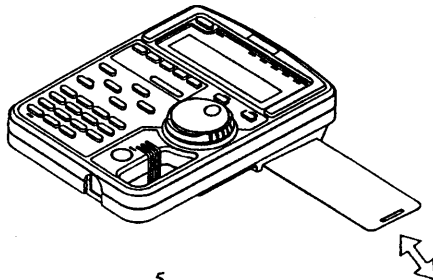

### Chapter 3. PRECAUTIONS

- 1) Never connect or disconnect the cable when power of the power supply is on. Before connecting the RC02-PAX/RC02-PBX cable, be certain that power of the power supply is off.
- 2) With the remote controller connected to the power supply, allow a period of 5 seconds or more before turning-on the power supply which has been turned off. That is, once you have turned-off the power supply, be sure to keep it in the off state for more than 5 seconds.
- 3) Do not attempt to control the power supply simultaneously from the front panel and from the remote controller. If you do this, the power supply may operate erroneously.
- 4) Pay attention so that no unreasonably large tension or other unfavorable force is applied to the cable that connects the remote controller to the power supply. If you handle the cable roughly, its 8P miniplug may be damaged.

Examples of rough handling:

- a) To suspend the remote controller with the cable
  - b) To pull the cable to disconnect the plug
- 5) Lay the cable neatly and safely along a secured path. Avoid, so far as avoidable, laying the cables on a floor--especially near a traffic path.
  - 6) Do not press the surface of the LCD (liquid crystal display) unreasonably strongly. If you do this, the life of the LCD may be shortened or the LCD may be damaged.
  - 7) At lower temperatures, the response speed of the LCD may become slower. This is not an abnormal indication.

## Chapter 4. INSPECTION AND MAINTENANCE

- 1) When the surface of the remote controller has become dirty, you may clean it. To clean the controller surface, use a cloth moistened with thin neutral soap-suds. Never use chemical detergent.

**Caution**

- Never use benzine, thinner or other chemical detergent. If you use it, the surface may be discolored, letters may become illegible, and the display may become cloudy.

- 2) Check the cable sheath and 8P miniplug for breakage.

### 4.1 Checkup Before Ordering Repair

When the remote controller has become failed seemingly, check it as described in this section in order to make certain that the remote controller has actually failed.

**WARNINGS**

- Never remove the cover of the remote controller. The internal components of the remote controller must be serviced only by the qualified electronics personnel.

#### Checkup Procedure

Symptoms	Items to be checked	NO	Remedies
No displays appear at all.	• Do displays appear on the power supply?	→	• The power supply has failed. Repair it.
	↓ YES	NO	
	• Are the cable plugs securely connected to the connectors?	→	• Securely connect the plugs.
	↓ YES	NO	
	• Is not the cable open-circuited?	→	• Replace the cable.
	↓ YES	NO	
	• Is the contrast control set properly?	→	• Properly set the contrast control.
	↓ YES		

Order your Kikusui agent for repair.

All keys do not work.

• Are the cable plugs securely connected to the connectors?

↓ YES

• Is not the cable open-circuited?

↓ YES

• Have not you connected or disconnected the cable when power of the power supply is on?

↓ YES

Order your Kikusui agent for repair.

NO

→

• Securely connect the plugs.

NO

→

• Replace the cable.

NO

→

• Turn-off power of the power supply once. After more than 5 seconds has elapsed, turn on power again.

## Chapter 5. SPECIFICATIONS

### 5.1 Ambient Conditions

Operable temperature:	0 to 40 °C
Operable humidity	: 30 to 80% RH (no condensation)
Storage temperature	: -20 to 70 °C
Storage humidity	: 20 to 80% RH (no condensation)

### 5.2 Display

20 columns × 2 rows, STN-type LCD.  
 Character structure: 5 dots × 7 dots.  
 with cursor

### 5.3 Power consumption

300 mW (typical)

### 5.4 Dimensions and Weight

Dimensions	: 180 D × 128 W × 50 H mm
Weight	: Approximately 400 g (excluding cable and magnet sheet)

### 5.5 Accessories

8-pin miniplug cable (2 meters long), with cable lock ....	1 piece
Magnet sheet (with seal on one side) .....	1 sheet
Operation manual .....	1 copy

Appendix: EXTERNAL VIEWS AND DIMENSIONS

[UNIT:mm]

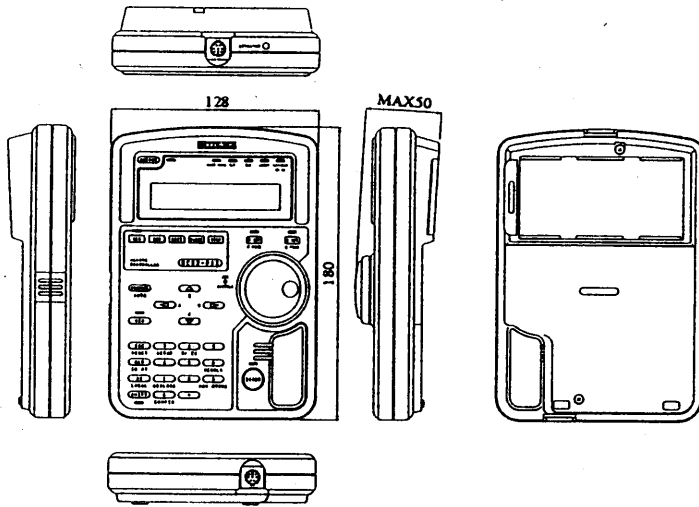

RC02-PAX

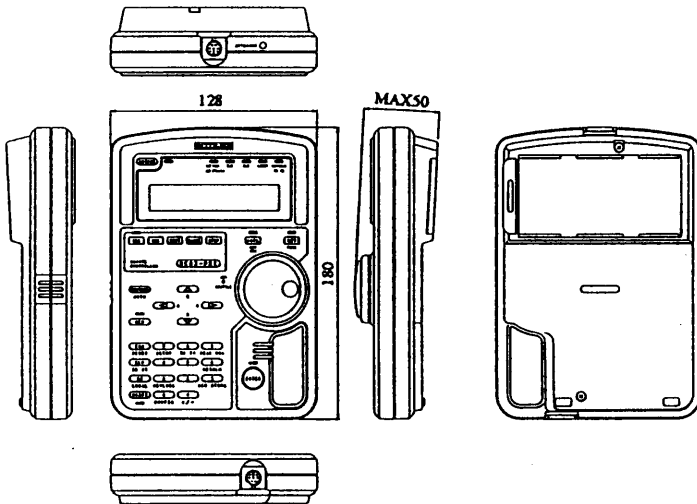

RC02-PBX

**KIKUSUI ELECTRONICS CORP.**

1-1-3, Higashiyamata, Tsuzuki-ku, Yokohama, 224-0023, Japan

Tel : 045-593-7570 Fax : 045-593-7571